

Pressure Switch MDR 4

3-phase; Switching capacity 4.0 / 5.5 KW
max.cut-out pressure 11 / 16 bar

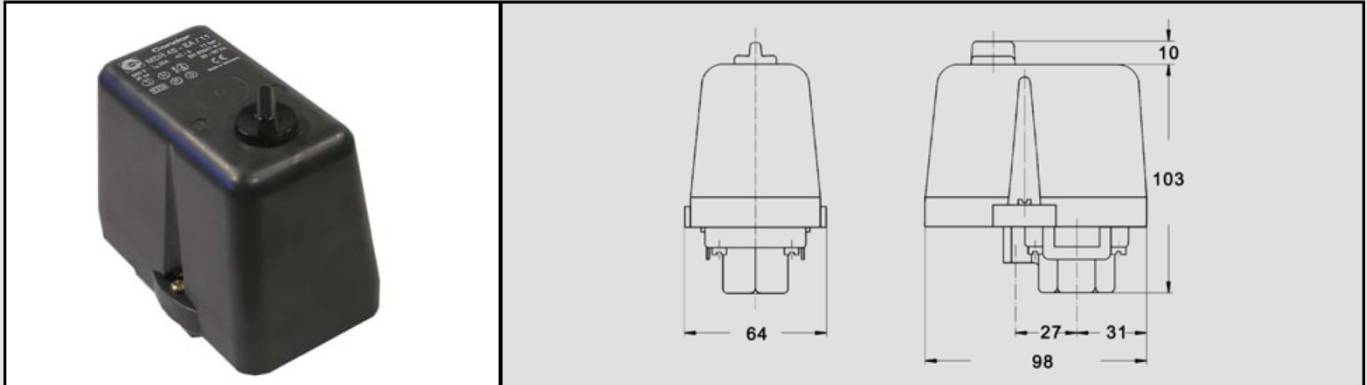

Technical Data

MDR 4 S

3 Pole Normally Closed

Technical Data MDR 4 S / MDR 4 SD acc. to EN 60947	
Rated insulation voltage U_i	500 V
Motor switching capacity (AC 3) $U_e=240$ V (1~)	2.5 kW
Motor switching capacity (AC 3) $U_e=230$ V (3~)	4.0 kW
Motor switching capacity (AC 3) $U_e=400$ V (3~)	5.5 kW
Motor switching capacity (AC 3) $U_e=500$ V (3~)	5.5 kW
Electrical life (AC 3) Cycles	$> 1 \times 10^5$
Mechanical life Cycles	$> 5 \times 10^5$
Max. electrical cycles Cycles/h	120
Max. mechanical cycles Cycles/h	600
Rated operational current I_o at 240 V AC	20 A
Bursting strength P_z	> 35 bar
Permissible medium temperature Air	- 5...+ 80 °C
Permissible medium temperature Water	+ 80 °C
Degree of Protection acc. to EN 60529	IP 44
Conductor cross-section 1 .. fine stranded cable 1 x / 2 x	2.5 / 2.5mm ²
Conductor cross-section 1 rigid cable 1 x / 2 x	2.5 / 2.5mm ²

MDR 4 SU (Reverse Acting)

3 Pole Normally Open

Technical Data MDR 4 SU acc. to EN 60947	
Rated insulation voltage U_i	500 V
Motor switching capacity (AC 3) $U_e=240$ V (1~)	1.5 kW
Motor switching capacity (AC 3) $U_e=230$ V (3~)	2.5 kW
Motor switching capacity (AC 3) $U_e=400$ V (3~)	4.0 kW
Electrical life (AC 3) Cycles	$> 1 \times 10^5$
Mechanical life Cycles	$> 5 \times 10^5$
Max. electrical cycles Cycles/h	120
Max. mechanical cycles Cycles/h	600
Rated operational current I_o at 240 V AC	20 A
Bursting strength P_z	> 35 bar
Permissible medium temperature Air	- 5...+ 80 °C
Permissible medium temperature Water	+ 80 °C
Degree of Protection acc. to EN 60529	IP 44
Conductor cross-section 1 .. fine stranded cable 1 x / 2 x	2.5 / 2.5mm ²
Conductor cross-section 1 rigid cable 1 x / 2 x	2.5 / 2.5mm ²

Diaphragm media resistance MDR 4 ..

Air, Water	resistant
------------	-----------

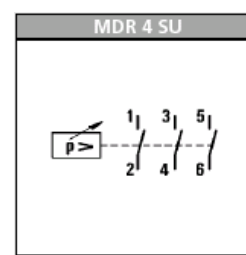
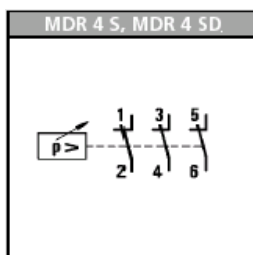

Ross Brown Sales

21 Brookhollow Ave, Baulkham Hills NSW 2153

The data provided above is for information purposes only and no warranty of accuracy or reliability is given. Ross Brown Sales Pty Limited reserves the right to change or modify this data without prior notice.

Ph: (02) 9899 2744

Fax: (02) 9899 4233

Email: sales@rossbrownsales.com.au

Rev 08/12

Pressure Switch MDR 4



Pressure Switches

Condor Code	ON/OFF switch	Pressure Range In kPa	Connection	Weight (gms)	Part Number
600 kPa					
MDR4S /600 G1/4 1PG11Z	-	150-600	¼" BSP F	490	310000
1100 kPa					
MDR4S /1100 G1/4 1PG11Z	-	400-1100	¼" BSP F	490	311000
MDR4S /1100 G1/2+M-1/4 1PG11Z	-	400-1100	¼" gauge + 1/2" BSP F	490	3115000
MDR4S /1100 G1/4 EV4i 1PG11Z	-	400-1100	¼" BSP F	530	3120000
MDR4S /1100 G1/4 EA 1PG11Z	EA	400-1100	¼" BSP F	530	3121000
MDR4S /1100 G1/4 EA EV4i 1PG11Z	EA	400-1100	¼" BSP F	530	3130000
MDR4S/1100 G1/4 EA EAS4 EV4-M5 2PG13.5Z	EA	400-1100	¼" BSP F	540	3130050
1600 kPa					
MDR4S /1600 G1/4 1PG11Z	-	600-1600	¼" BSP F	490	3140000
MDR4S /1600 G1/4 EA AEV4 2PG11Z	EA	600-1600	¼" BSP F	490	3140012
MDR4 SU (Reverse Acting)					
MDR4SU/600 G1/4 -	-	150-600	¼" BSP F	480	3149000
MDR4SU/1100 G1/4 -	-	400-1100	¼" BSP F	480	3149200
MDR4SU/1600 G1/4 -	-	600-1600	¼" BSP F	480	3149400

Pressure Switch Accessories

Condor Code	Description	Weight (gms)	Part Number
Unloader valves			
EV4i	With screw fitting for ¼" plastic or copper discharge line	25	3910000
EV4-M5	With screw fitting for 6 mm plastic or copper discharge line, mounting of silencer possible, port with M5 thread	25	On Request
Unloader valves for difficult motor starting conditions			
AEV4	With screw fitting for 6 mm plastic or copper discharge line	25	3910100
AEV4W	Right-angle valve with screw fitting for 6 mm plastic or copper discharge line	15	On Request
Cable Glands			
PG11Z	With strain Relief	12	3919200
Cover			
H4 S	Cover without rotary knob for MDR4 S	70	On Request
H4S-EA	Cover with rotary knob for manual On/Off switching for MDR 4S	70	3915000

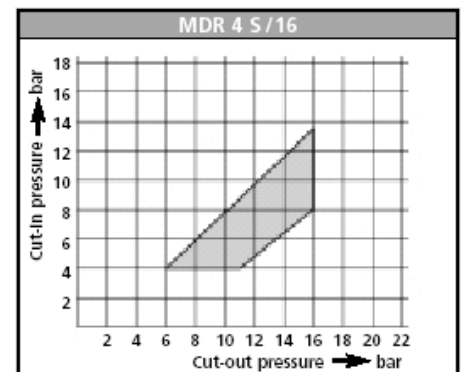
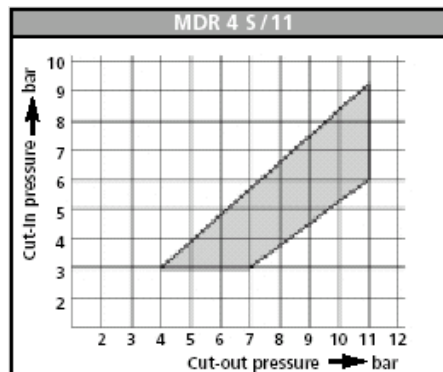
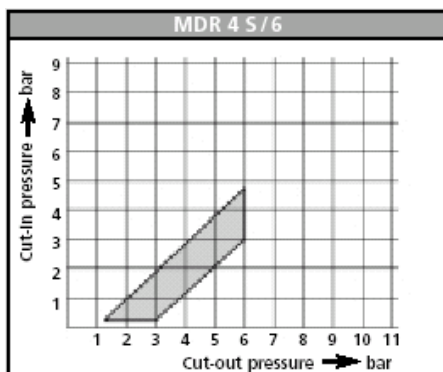
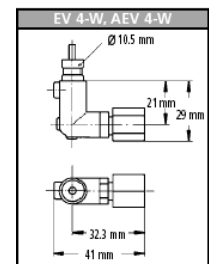
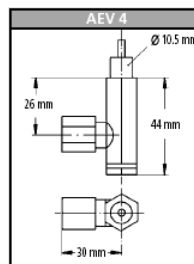
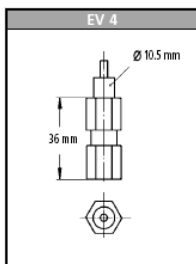

The data provided above is for information purposes only and no warranty of accuracy or reliability is given. Ross Brown Sales Pty Limited reserves the right to change or modify this data without prior notice.

Rev 08/12